



M2M Sensor Security and Trust Zone

Qi Chen

Emerging Solutions Group

Sprint

Overview

- *M2M Overview*
- *M2M Sensor Network Security*
- *M2M Verticals and Security Issues*
- *Message and Alert Delivery*
- *Guaranteed Message Delivery*
 - *Location assisted*
 - *Network monitoring*
- *Concept of TrustZone*
 - *Software hardware and system architecture*
 - *Usage of TrustZone in M2M sensor network*

M2M Sensor Network Security Overview

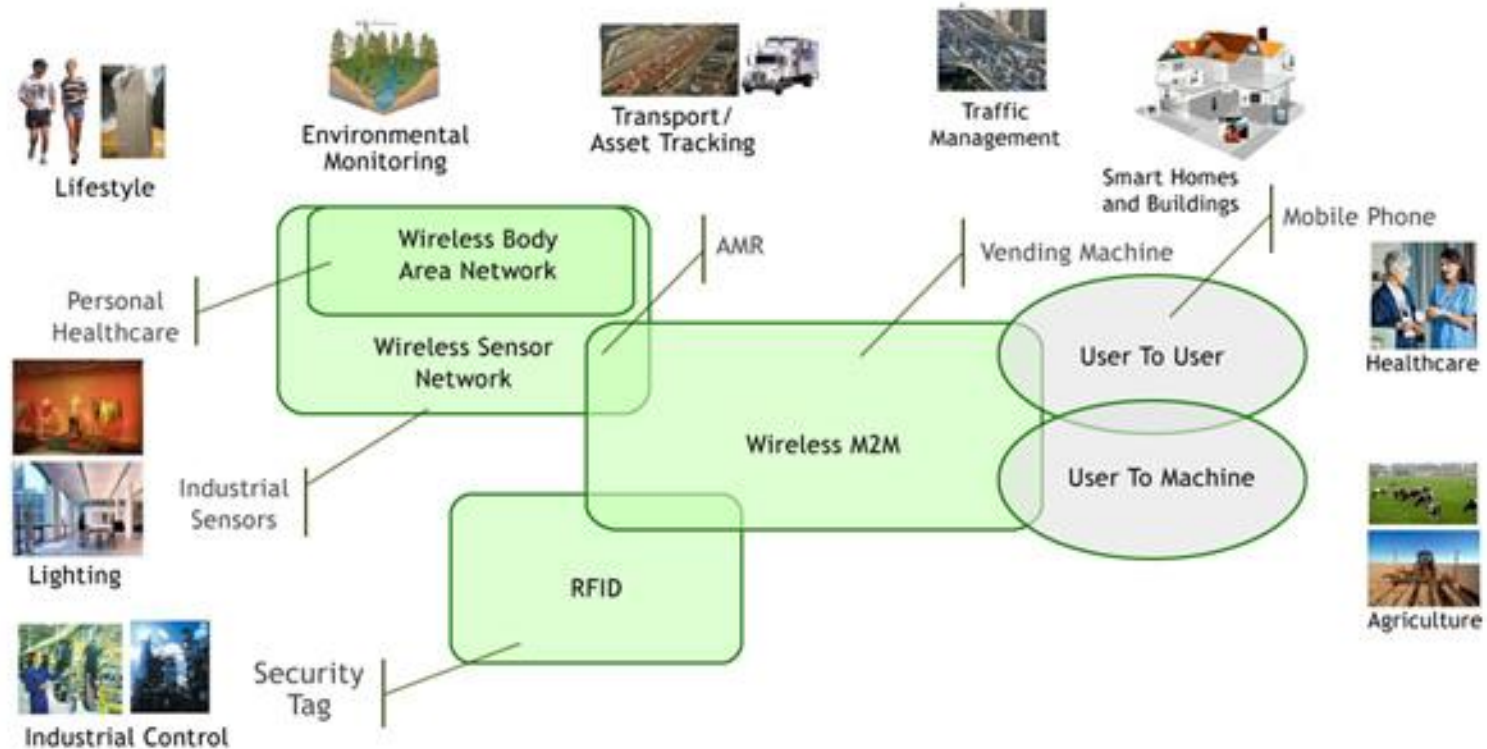

Explosive Growth Expected for M2M

Caution: Explosive Growth Potential!

M2M Magazine, 04/2010

There will be 2.1 billion M2M connected devices by 2020.

Analysys Mason, 12/2010

Yes, we suggest you sleep with one eye open, because the machines are taking over. Resistance is futile.

Engadget, 10/2010

80 million M2M devices are expected to be connected in North America by 2015.

ABI Research, 10/2010

Global M2M module market forecast to reach \$3.8 billion in 2015.

ABI Research, 08/2010

M2M Verticals and Security Threads

Healthcare:

Medical sensors

Patient credentials: Connected Ambulance

M2M Verticals and Security

Fleet Management:

Vehicle diagnostic: Accuracy of Information

Connected Vehicle: Real accident reporting



M2M Verticals and Security

Telemetry:

Smart meter sensors: Electricity meters

SCADA system: Building management

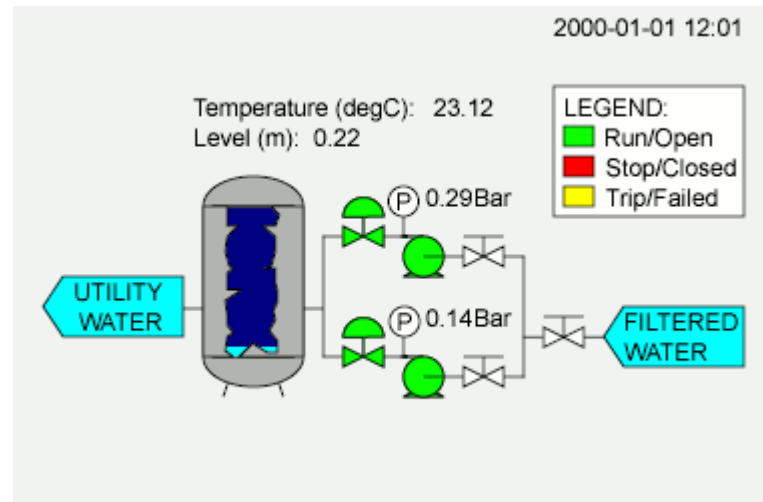

M2M Verticals and Security

Embedded systems:

Lack of authentication and encryption



M2M Verticals and Security

*Mobile Commerce:
POS, Wireless ATM*



M2M Verticals and Security

Video Surveillance: Security Cameras, image analysis



M2M Security

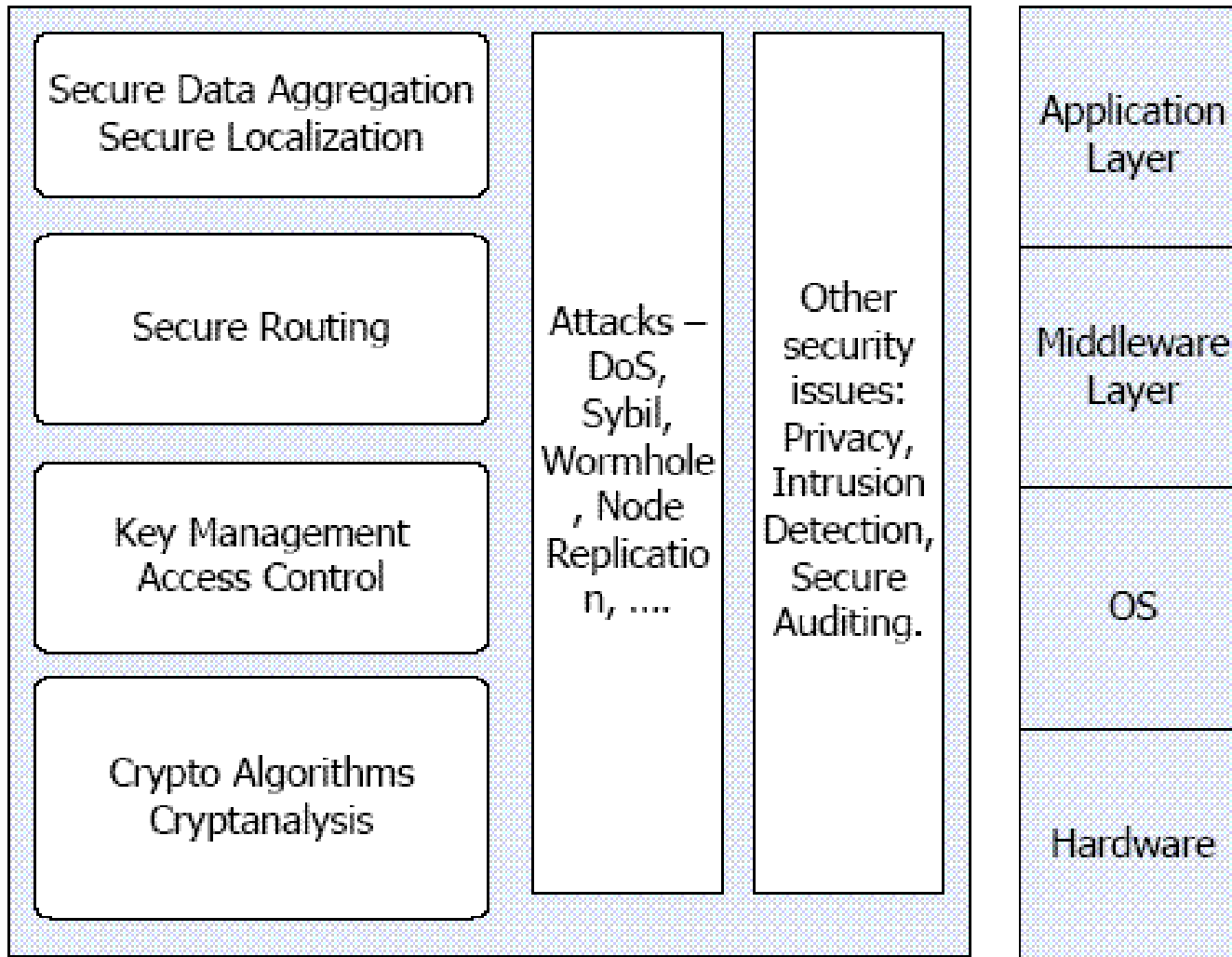

Alert Delivery

Common Alert Types:

SMS

Email

Pager

E.g. Oil and Gas Industry, Healthcare

Alert delivery is critical

Backup delivery method and channel should be used

Delivery confirmation should be required

Guaranteed Message Delivery

Non IP based SMS will always be delivered when the device becomes available, but not always in a timely fashion.

SMS Cellular Network

SMS over MSC:

Messages are stored in the network until the destination cell phone becomes available

SMS over SMTP:

Lack of speed, non-guaranteed delivery,
Email simply wasn't designed to provide quick, guaranteed delivery.

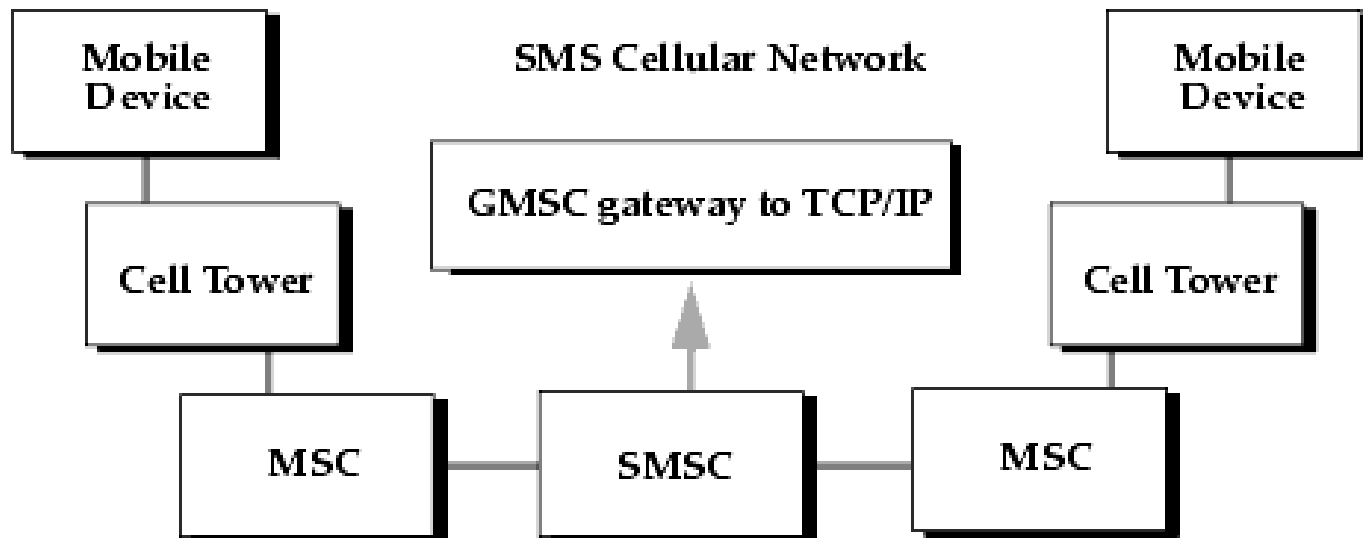

Location Aware SMS Delivery

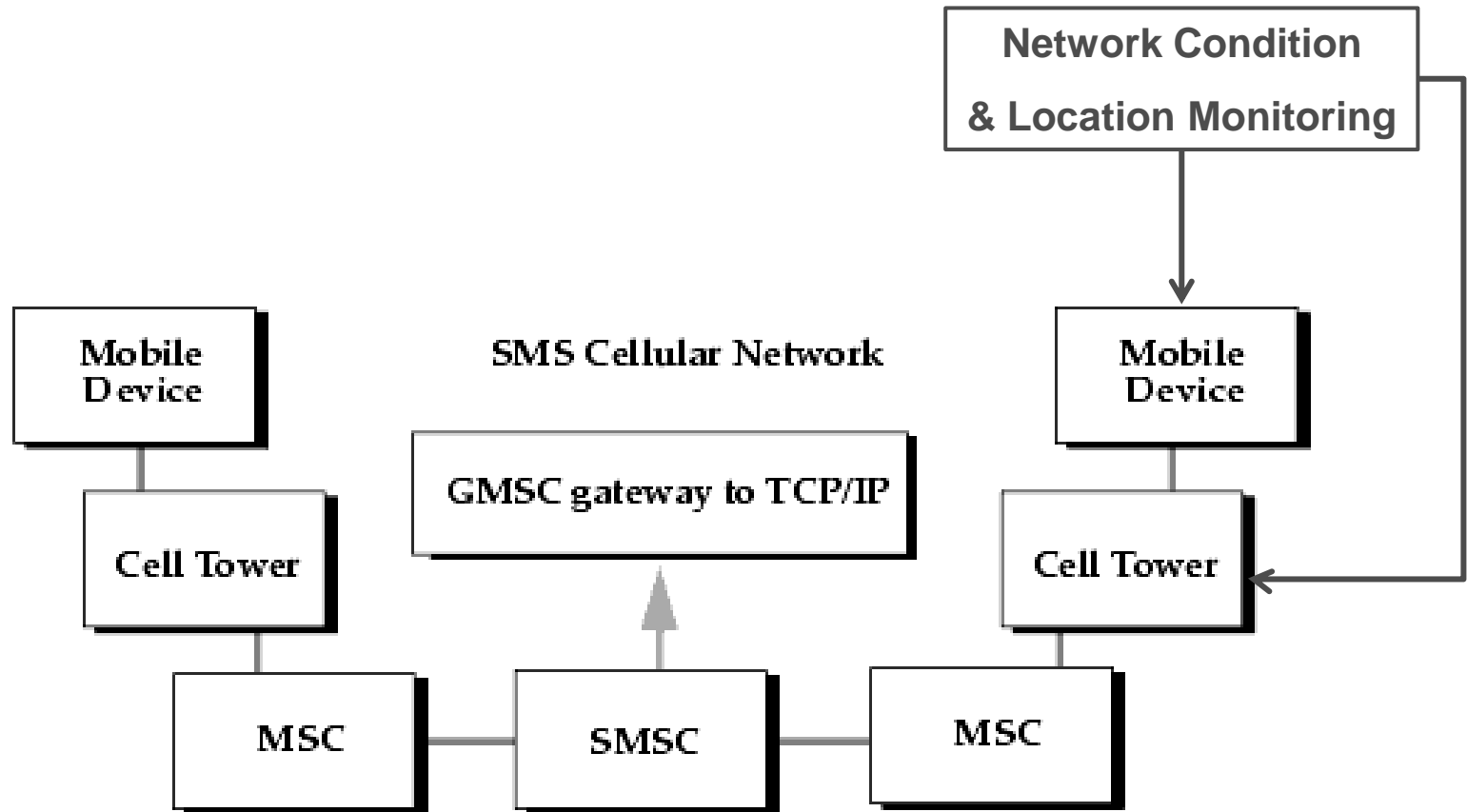

Location Assisted SMS Delivery

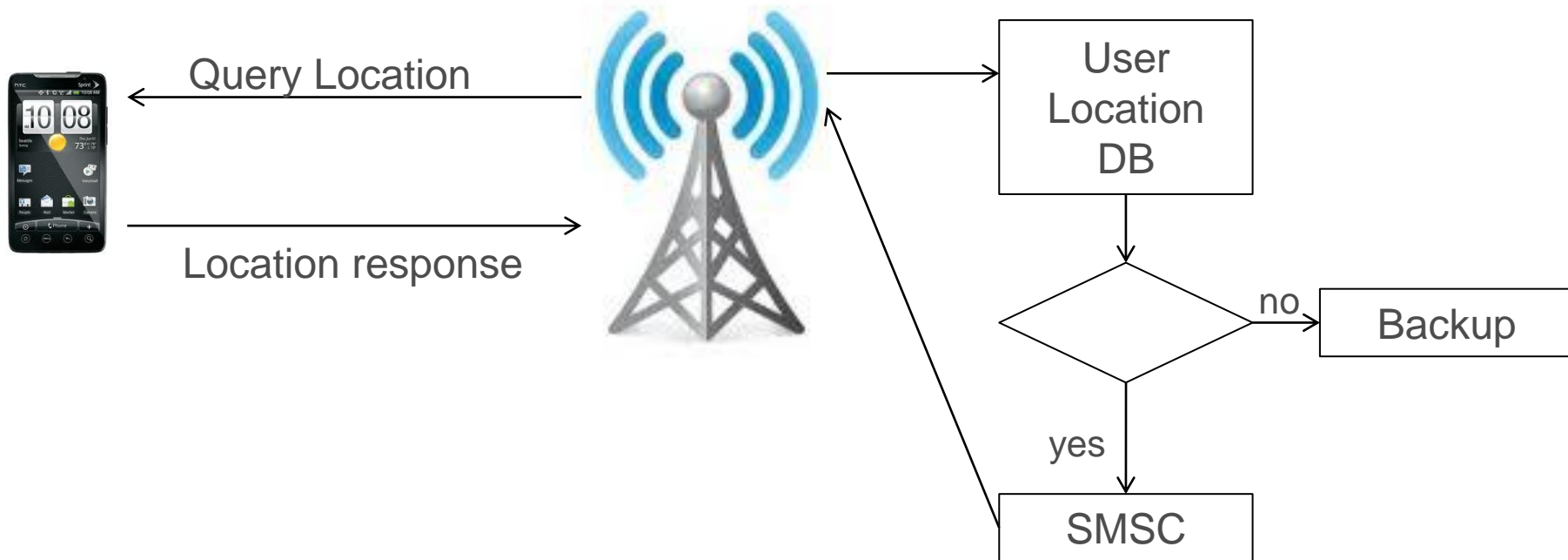

Guaranteed Alert Delivery

Adjust
monitoring
interval

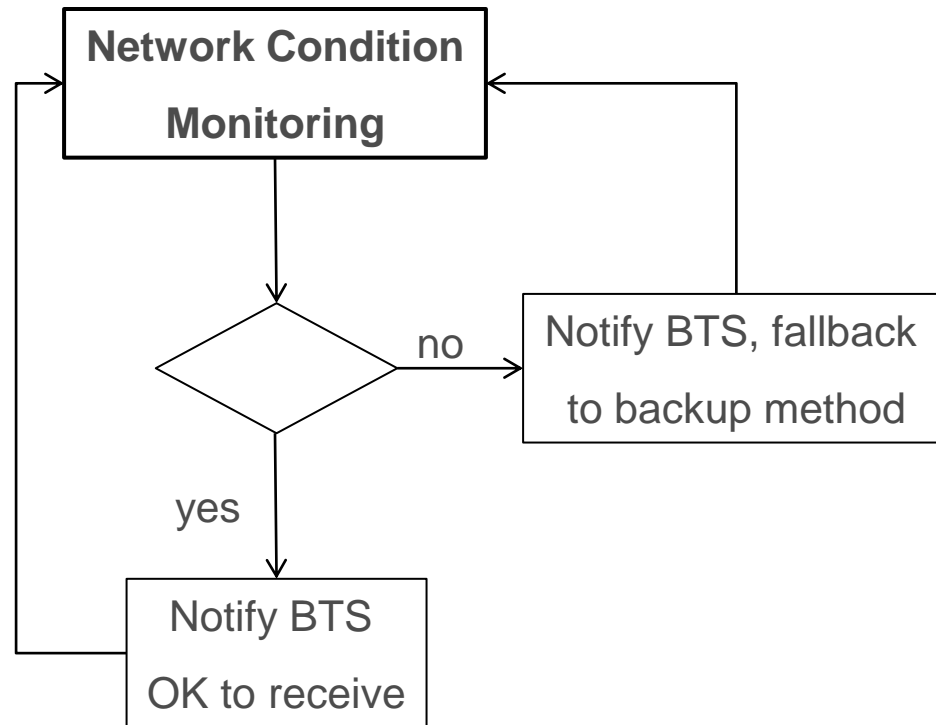

Trust Zone

TrustZone® technology is a system-wide approach to security on high performance computing platforms for a huge array of applications including secure payment, digital rights management (DRM), enterprise and web-based services.

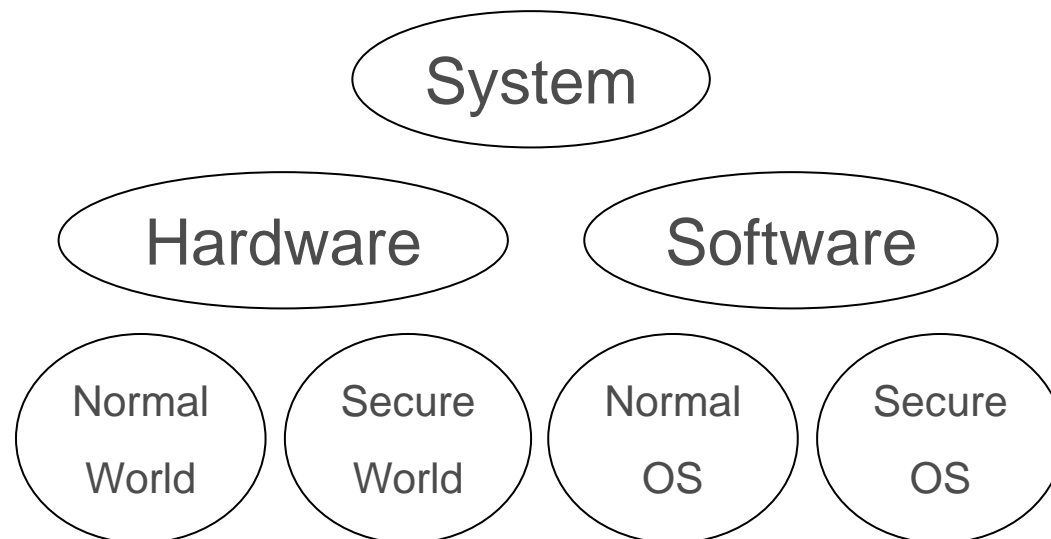

Trust Routing

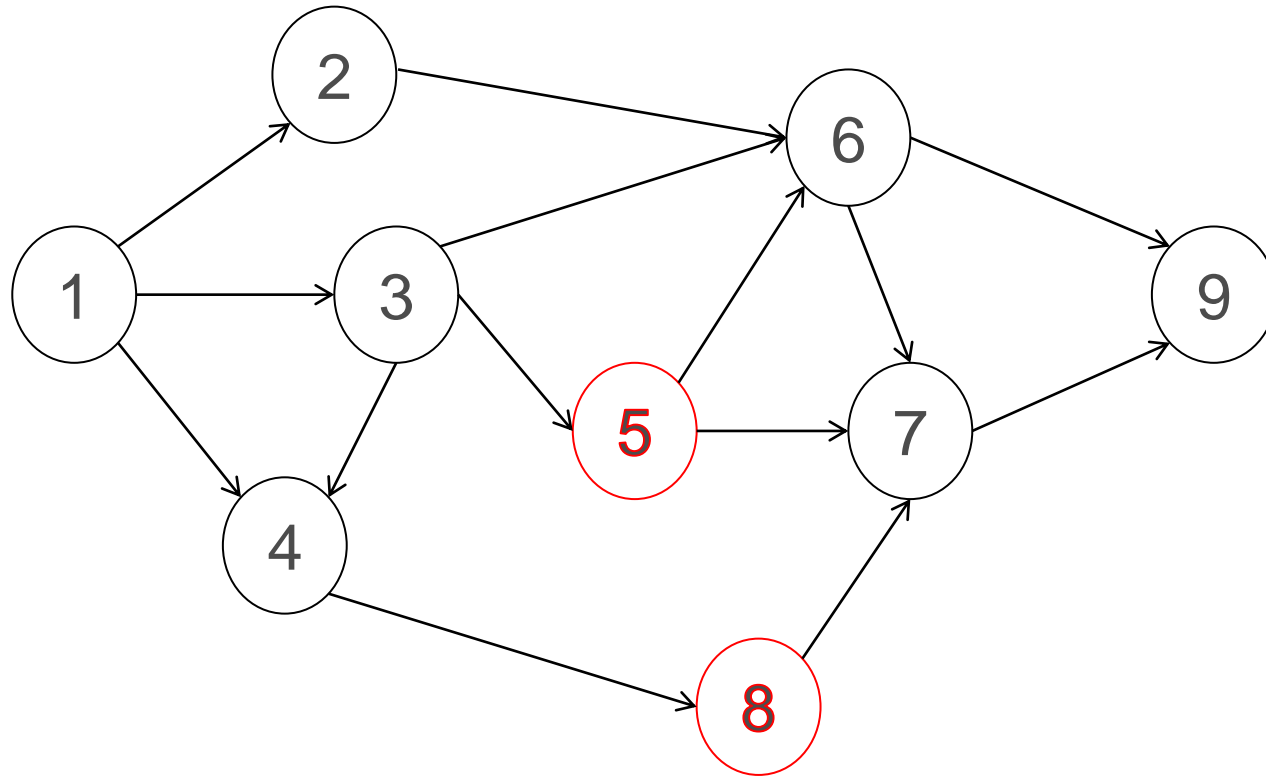

Malicious nodes: 5, 8

Route is selected based on reward score

Learning system is needed: e.g. LCS, genetic algorithms

Q & A